

gsr 209T

shortform operating instructions



self drive access

This book is designed as a guide to enable you to start work quickly and safely. It is not intended to replace the full manufacturer's operating instructions (a copy of which should be with your machine) which should be read and understood by anyone operating the machine.

SAFETY TIPS

ALWAYS

- Inspect your machine before use.
- Check all operations including ground controls.
- Check ground conditions.
- Check clearance from overhead obstructions (power cables, building projections etc).
- Plan your task/job.
- Use sole boards under your outriggers at all times regardless of ground conditions.
- Stabilise and level machine before use.
- Wear a safety harness connected to a suitable anchorage point inside the platform.
- Operate all controls smoothly.
- Warn other people that you are there by means of flashing lights, sign and cones.
- MAKE SAFETY YOUR No.1 PRIORITY.

NEVER

- Use an unsafe machine.
- Use an access platform to hoist loads like a crane.
- Overload cage/platform.
- Operate in strong winds (Check manufacturer's recommendation).
- Rest the cage on a structure or object to gain extra support.
- Attach your safety harness to a structure outside of the platform.
- Throw or drop anything from the platform.
- Use boxes, ladders or stand on handrails to gain additional height, if you can't reach, you need a bigger machine.
- Let an untrained person operate the access platform.
- Take unnecessary risks (hospitals and graveyards are full of dead heroes!)

**In the unlikely event that your machine develops a fault
please contact the Facelift Tech Team on 01444 881100**

CONTENTS

Preliminary Checks	1	Foreseeable Special Use Operations	11
Operation and Use	1	Troubleshooting	12
Use and Restrictions	7	Notes	13
General safety Rules.....	9		

PRELIMINARY CHECKS

CHECKS AT THE TIME OF DELIVERY

Make sure the machine is provided with:

- EC compliance statement;
- Use and Maintenance manual;
- Work platform manual;
- Fire extinguisher in working condition;
- First aid kit.

PRELIMINARY CHECKS BEFORE SETTING AT WORK

Every day, before starting up the engine of the vehicle, you must perform the following checks:

- check the level of the fuel in the tank and top up if necessary;
- make sure daily and routine maintenance have been performed as described in the section on "Maintenance-D".
- check the machine on the outside and its equipment, look for any break-ages or damages of the components or the structure. Should you come across any problems, do not use the platform, and call in an Authorised Repair Shop;
- check for any fluid leakages and if necessary eliminate them;
- check the level of the hydraulic oil using the relevant indicator;
- check cleanliness and get rid of any accumulation of debris on the telescopic booms, on the articulations, on the reach limiter, etc.;
- make sure there are the wrenches to actuate the emergency controls and the handle to use the emergency pump if provided.

To check fluid levels, follow the instructions in the section on "Maintenance"



WE SUGGEST YOU CHECK THE LEVELS AT THE END OF THE WORKING DAY, WHEN THE FLUIDS ARE CERTAINLY AT THEIR WORKING TEMPERATURE. WE ALSO SUGGEST YOU FILL THE FUEL TANK AT THE END OF THE WORKING DAY SO AS TO AVOID CONDENSATE GATHERING INSIDE THE TANK DURING THE NIGHT.

Now start up the engine and make sure that:

- the parking brake is engaged, check the proper position of the control lever and make sure its light goes on on the dashboard;
- the gear lever is in idle position;
- the engine is running at the minimum number of revs to engage the power take-off.



SHOULD YOU HAVE TO WORK AT TEMPERATURES NEAR 0°C, LET THE MACHINE RUN IDLE FOR ABOUT TEN MINUTES, IN ORDER TO WARM UP THE HYDRAULIC FLUID.

USING THE MACHINE

Before using the machine, you must:

- Choose where to park the vehicle, making sure that the place is sufficiently levelled. Check the area for holes, underground pipes, manholes, weak ground, hanging lines (power, telephone, etc.).
- Fence off the area within the range of the machine and put up appropriate signs.
- Stabilise the machine according to the instructions of the chapter on "Stabilisation – C-2.2".

OPERATION AND USE

ENGAGING THE POWER TAKE-OFF

The power take-off may have:

- pneumatic clutch. In this case, press the clutch pedal to actuate the pneumatic switch.
- a mechanical clutch (29). In this case, press the clutch pedal and push its lever down (29). This is usually to the left of the driver's seat.

Once the power take-off has been engaged, as shown by the light (40) lighting up on the dashboard, make sure the engine is turning at about 750 rpm.

The actuation of the power take-off simultaneously actuates the MEWP control electric circuit.



IT IS ABSOLUTELY FORBIDDEN TO USE THE PLATFORM WITH THE ENGINE AT A HIGHER NUMBER OF REVS. LACK OF COMPLIANCE WITH THIS COULD LEAD TO SERIOUS DAMAGE TO THE HYDRAULIC CIRCUIT DUE TO OVERHEATING OF THE OIL OR COULD LEAD TO DANGEROUS MANOEUVRING SPEED AND/OR COMPROMISE THE OPERATION OF THE SAFETY DEVICES.

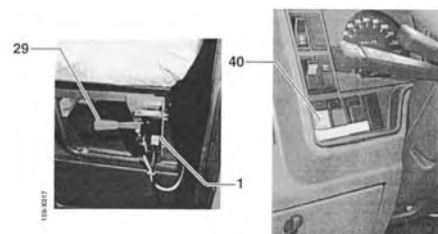

Fig. 01-C

STABILISATION

After having positioned the vehicle, stabilise it as follows:



MAKE SURE NOBODY IS NEAR THE MACHINE BEFORE ACTUATING THE STABILISER CONTROLS.

SHOULD THE GROUND BE WEAK, PUT THE INCREASED PLATES (PROVIDED AS OPTIONAL DEVICES BY THE MANUFACTURER) OR SUITABLE HARD WOODEN PLANKS BETWEEN THE GROUND AND THE FEET.

- First bring down the front stabilisers, so as not to overload the front part of the vehicle. At the same time, press on the handshake lever (E) and – one at a time – on the control levers (C) and (D), until the wheels of the vehicle are roughly 10 mm above the ground.
- Lower the rear stabilisers pressing simultaneously on the handshake lever (E) and – one at a time – on the levers (A) and (B).



SOME MEWPS MAY BE SET UP WITH ONLY TWO STABILISERS, WHILE ON OTHER MACHINES, WHEREAS ON OTHER MACHINES THE TYRES OF THE VEHICLE MAY HAVE TO CONTRIBUTE TO THE STABILITY OF THE RAISED PLATFORM. IN SUCH CASES, IT IS NECESSARY TO LEAVE AT LEAST 2 WHEELS OF THE VEHICLE (GENERALLY THE FRONT ONES) RESTING FIRMLY ON THE GROUND. AT THE SAME TIME, AND BEFORE ANY USE, YOU MUST CHECK THE PERFECT CONDITION AND WORKING PRESSURE OF THE TYRES. BEFORE USING THE MACHINE, CHECK ON THE “CHECK BOOK (ENCLOSURE 8)” WHETHER AND HOW THE TYRES SHOULD REST ON THE GROUND SO AS TO HELP STABILISE THE RAISED PLATFORM.

- Stabilise the vehicle lifting the various stabilisers as needed, checking the slant by means of the level indicator (65). Make sure the bubble is within' the small circle inside the window: the slant of the vehicle must not exceed the maximum permitted value of 1°.

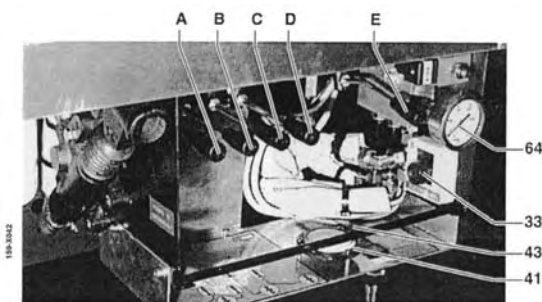

THE PLATFORM MUST NOT BE USED IF ALL THE STABILISERS ARE NOT SUFFICIENTLY EXTENDED AND FIRMLY SUPPORTED ON THE GROUND. FOR MACHINES PROVIDED WITH OBLIQUE STABILISERS, YOU MUST EXTEND THE STABILISERS UNTIL THE GREEN STRIP ON THE SAME APPEARS, OTHERWISE THE MINIMUM WIDTH NECESSARY FOR PROPER STABILISATION WILL NOT BE ENSURED.

ON WORK PLATFORMS PROVIDED WITH DIAGONAL FRONT STABILISERS AND VERTICAL REAR

STABILISERS, IT WILL ALWAYS BE NECESSARY TO REST THE DIAGONAL STABILISERS ON THE GROUND FIRST, SINCE OTHERWISE THERE WOULD BE A RISK OF DAMAGING THE REAR VERTICAL STABILISERS DUE TO THE MOVEMENT OF THE VEHICLE.



IT IS ALWAYS FORBIDDEN TO USE THE PLATFORM WITHOUT THE STABILISERS PROPERLY RESTING ON THE GROUND.

BEFORE GETTING UP ON THE PLATFORM, THE OPERATOR MUST PHYSICALLY MAKE SURE THAT:

- the blue warning light (43), showing proper stabilisation of the vehicle and hence actuation of the work platform controls, is ON;
- all the stabilisers are properly extended and supported on firm ground;
- the wheels of the vehicle are properly positioned on the ground according to the instructions in the check-book “Enclosure 8”;
- the general conditions are compatible with the use of the MEWP;
- check the daily check-list;
- check operation of the limiter as described in the chapter on “Checking the operation of the reach limiter – D-3.14”.

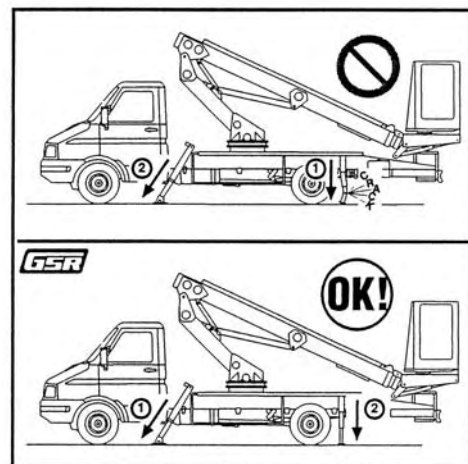

USE OF THE PLATFORM

- Check the efficiency of the safety devices using the emergency controls with no operator in the work platform, as described in the chapter on “Emergency operation – C-2.1”.
- Make sure the emergency control station is manned by an expert operator.
- Go up onto the platform with the necessary equipment.
- Make sure not to exceed the workload (see chapter “Rated load – A-3.4.1”).
- Make sure the closing bars (gravity closure) of the work platform access compartments are entirely lowered.
- Fasten the safety belt and hook it onto one of the special eyeholes on the work platform.



MAKE SURE NO PEOPLE ARE NEAR THE WORK PLATFORM OR THE MACHINE BEFORE YOU ACTUATE THE CONTROLS.

- Check proper levelling of the work platform, and level if necessary, releasing the relevant control and operating on its lever (M – Fig. 03-C) according to the instructions in the chapter “Lever functions – B-2.3.1 .2.-M”. The work platform must be properly levelled at 00 before use, whatever the slope the vehicle is positioned at on the ground.
- Carefully lift the work platform so as not to damage the end of the stand.



A MISTAKEN MOVEMENT (ESPECIALLY OF ROTATION OR DESCENT) CAN CAUSE SERIOUS DAMAGE TO THE VEHICLE, THE STAND OR THE MEWP.

- Make sure the controls coincide with the actual movements of the MEWP by making slight shifts of the control levers (see chapter on “Components and controls in the work platform – B – 2.3”).



THE PLATFORM IS NOT ELECTRICALLY INSULATED.

BEFORE BRINGING THE PLATFORM UP TO ITS WORKING LEVEL, MAKE SURE THERE ARE NO FIXED OBSTACLES WITHIN THE RANGE OF THE BOOM.

IF THERE ARE ANY LIVE POWER LINES, DO NOT COME ANY NEARER THAN THE SAFETY DISTANCE (MINIMUM 5M).

THE OPERATOR IS RESPONSIBLE FOR MAKING SURE THAT THE MAXIMUM LOAD PROVIDED FOR IS NEVER EXCEEDED ON THE WORK PLATFORM.

TECHNIQUES OF USE

- It is good practice to make yourself familiar with all the controls in an area without any obstacles or people before actually using the machine. Take the utmost care and work at low speed. Lack of attention is a frequent reason for accidents.
- Do not insist on using a control if the stress should be such as to make the pressure release valve trip.
- Do not work simultaneously (unless necessary) at the maximum carrying capacity and the maximum reach.
- Do not exert vertical pressure when the work platform or the boom is resting against something.

- Do not apply lateral loads to the work platform or the boom either when it is turning or when it is still.
- Do not reverse the direction of rotation until the turret has come to a stop. The same rule applies for every kind of movement.
- Should visibility be poor, stop working.
- Should wind speed be higher than 6° Beaufort (45 km/h) stop working.

Function of controls in the work platform

The following functions are obtained by turning the levers in the direction shown by the arrows and numbers:

- 1 To lift telescopic (main) boom;
- 2 To lower telescopic (main) boom;
- 3 To make extension come out;
- 4 To make extension retract;
- 5 Clockwise turret rotation;
- 6 Counter-clockwise turret rotation;
- 7 To lift jib (only on TJ/TJV series);
- 8 To lower jib (only on TJ/TJV series);
- 9 Work platform counter-clockwise rotation (Optional);
- 10 Work platform clockwise rotation (Optional);
- 11 To lift work platform levelling;
- 12 To lower work platform levelling;

Also, the following push-buttons are present on the control panel:

- 33 emergency motor pump actuation push-button (optional)
- 31 vehicle engine start up push-button
- 30 emergency stop push-button
- 32 vehicle engine stop push-button

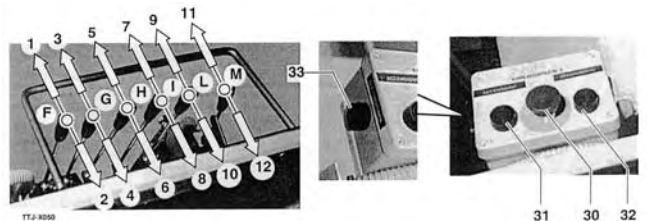

For more detailed information, refer to the chapter on “Components and controls on the work platform – 8-2.3”.

Movement towards the working position must always be performed in the following sequence: Lifting (1F); Rotation (clockwise – 5H/counter-clock-wise – 6H); Extension (3G); Jib manoeuvre (71/81) (only on Ti/TJVseries).

- Approach the working position avoiding brusque or fast movements.
Also, pay special attention not to let the work platform or boom rest against outside structures.
- When using the MEWP, vertical thrusts are not permitted.
- Horizontal outward thrusts of the work platform must not exceed:
20 duN for one operator,
40 daN for two or more operators.



HORIZONTAL THRUSTS – FROM THE WORK PLATFORM ARE FORBIDDEN WHILE THE MACHINE IS MOVING. PERMITTED HORIZONTAL THRUSTS MAY BE PERFORMED ONLY WHILE THE MACHINE IS NOT RUNNING.

- It is forbidden for the operator to go onto, leave and/or load the platform after it has been raised up from its travelling position.

PLATFORM RETRACTION

Position the work platform in its resting position proceeding as follows:

- retract the extensions of the telescopic boom completely (4G – Fig. 03-C);
- turn the turret using the relevant lever (5H-6H – Fig. 03-C) until the indexes (1) on the turntable coincide;
- turn the work platform to the centre (9L-10L);
- lower the job almost completely (81 – Fig. 03-C) (only on the Ti/TJV series);
- lower the main boom (2F – Fig. 03-C) until it rests on its stand;
- close the jib completely (81 – Fig. 03-C) (only on the TJ/TJV series);



IF THE PLATFORM IS NOT PROPERLY MADE TO REST ON THE STAND, IT WILL NOT BE POSSIBLE TO RETRACT THE STABILISERS. ALSO, A MISTAKEN MOVEMENT (ESPECIALLY ROTATION OR DESCENT) CAN CAUSE SERIOUS DAMAGE TO THE VEHICLE, THE STAND OR THE MEWP.



IT IS ALWAYS FORBIDDEN TO TRY TO MANOEUVRE THE STABILISERS UNLESS THE BOOMS HAVE BEEN BROUGHT BACK TO THEIR TRAVELLING POSITION. THE USER IS ALWAYS RESPONSIBLE FOR PHYSICALLY CHECKING THIS CONDITION. COME DOWN FROM THE WORK PLATFORM, BEING CAREFUL NOT TO LEAVE ANY LOADS INSIDE IT.



A LOADED PLATFORM COULD BE SERIOUSLY DAMAGED BY THE DYNAMIC OVERLOADS GENERATED DURING MOVEMENT ON THE ROAD. IT IS ALSO A SERIOUS DANGER BECAUSE OF THE POSSIBILITY OF THE OBJECTS CONTAINED IN THEM FALLING DOWN.

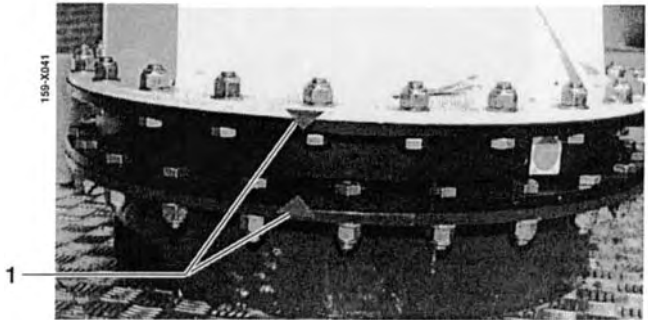

STABILISER RETRACTION

In order to retract the stabilisers, you must bring the work platform to its resting position. When the boom rests on the stand, it presses against the Boom/Stabiliser interlocking device piston, which enables actuation of stabiliser controls through the operation of two limit switches. At this point, one can retract the stabilisers, operating the lever (E) and simultaneously pushing upwards – one by one – the levers (A) and (B) and the levers (C) and (D). In order not to overload the front axle, we suggest you retract the front stabilisers first and then the rear ones. Make sure the yellow warning lights (41) – one is situated in the stabiliser control compartment, the other is situated on the cab dashboard – are off; otherwise retract all the stabilisers properly.

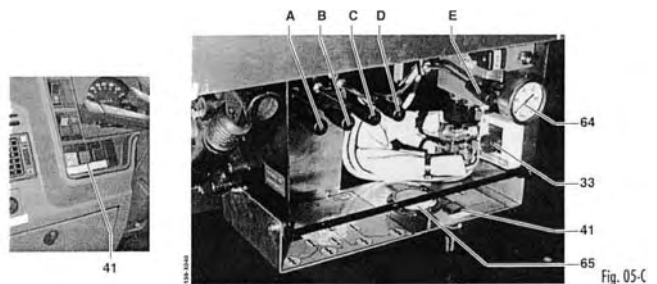

DRIVING WITH THE STABILISERS NOT COMPLETELY RETRACTED AND THEREFORE OUTSIDE THE PROFILE OF THE VEHICLE CAN CAUSE SERIOUS ACCIDENTS AND DAMAGE TO THE STABILISERS. THEREFORE YOU MUST PERFORM A SIGHT-CHECK OF THE STABILISERS AFTER HAVING MADE SURE THAT THE RELEVANT CONTROL LIGHTS ARE OFF. CHECK THE CONDITION OF THE WARNING LIGHTS BEFORE AND WHILE DRIVING, SO AS TO AVOID HAVING PROBLEMS.

Before starting to drive, you must:

- Close the stabiliser control hood (optional) using its key.
- Disengage the power take-off.
- Make sure the power take-off engagement warning light is off.



THE POWER TAKE-OFF, IF LEFT ENGAGED WHILE DRIVING THE VEHICLE, CAN BE DAMAGED AND CAUSE SERIOUS DAMAGE TO THE VEHICLE. THE MANUFACTURER SHALL BE HELD HARMLESS FOR ANY DAMAGE DUE TO LACK OF COMPLIANCE WITH THESE INSTRUCTIONS.

- Make sure you have closed any cabinets and fastened their covers.
- Inspect the vehicle and make sure the MEWP is completely folded down in its travelling position.

EMERGENCY OPERATION

Emergency operation is required in the following cases:

- 1 Stoppage due to tripping of any emergency push-button,
- 2 Fault on the thermomotor or main pump;
- 3 Fault on the wiring system or tripping of any safety micro-switch (on chains, reach limiter etc.);
- 4 Platform retraction using emergency controls.



DURING AN EMERGENCY, YOU MUST PERFORM ONLY THOSE MANOEUVRES WHICH ALLOW THE WORK PLATFORM TO COME BACK DOWN. THE OPERATOR IS RESPONSIBLE FOR KEEPING THE MACHINE WITHIN THE WORKING RANGE.

Stoppage due to tripping of any emergency push-button

The presence of an actual or presumed danger may lead an operator suddenly to press the emergency mushroom push-button on the work platform control panel. This will stop every function on the machine. Another push-button, of the same shape and function, is situated on the emergency panel on the turret and is protected by a hood with a lock, so it can be used only by the operator on the ground. To restore operation you must:

- Remove the reason, if it exists, which made the operator press the emergency push-button;
- Turn the emergency push-button in the direction shown by the arrow on it, to restore it;
- Actuate the controls according to the manoeuvre you intend to perform.



SHOULD THE EMERGENCY SLOP PUSH-BUTTON HAVE BEEN PRESSED BECAUSE OF MALFUNCTION OF THE CONTROLS OR OF THE MACHINE, IT IS IMPORTANT NOT TO RESTORE THE EMERGENCY PUSH-BUTTON, BUT TO ADVISE THE OPERATOR ON THE GROUND OF THE PROBLEM WHICH HAS TAKEN PLACE. IN CASE OF DOUBT, STOP OPERATIONS AND IMMEDIATELY INFORM THE AFTER-SALES SERVICE, AVOIDING ANY DANGEROUS MANOEUVRE.

Fault on the thermomotor or main pump

In these cases, you can use the hand pump (62) or the emergency motor pump (pressing the push-button 33 on Fig. 07-C), according to the version you have, or else actuate the electro-hydraulic control box (optional), in order to permit manoeuvring the boom to bring the work platform back down to the ground.



USE THE EMERGENCY MOTOR PUMP ONLY IN CASE OF REAL NEED. DO NOT USE IT FOR MORE THAN 3 MINUTES IN ORDER TO AVOID MOTOR OVERHEATING.

IT IS ABSOLUTELY FORBIDDEN TO USE MORE THAN ONE PUMP AT A TIME.

Should no motor pump have been installed, you must use the hand pump as described in the following chapter.

Fault on the electric circuit and/or tripping of any safety micro-switch

In case of fault on the electric circuit (no power), power will cease to be fed to the main solenoid valve, which will therefore open. In order to manoeuvre the MEWP, you must try to work with the key switch (37) turned; should you not succeed, you must take the lead seal off the push-button (18) (which by-passes the solenoid valve) and keep it pressed down in order to manoeuvre the MEWP.



THE PUSH-BUTTON (18) MAY HAVE ITS SEAL TAKEN OFF AND MAY BE USED ONLY WHEN THE KEY SWITCH (37) IS NO LONGER OPERATIVE. SINCE IT CUTS OFF THE OPERATION OF THE SAFETY CIRCUITS, THE OPERATOR ON THE GROUND MUST MAKE SURE THAT HE IS NOT CARRYING OUT ANY DANGEROUS MANOEUVRES. HE MUST FIRST OF ALL RETRACT THE EXTENSIONS COMPLETELY AND THEN LOWER THE MEWP TO THE GROUND. THE OPERATOR IS RESPONSIBLE FOR SEEING THAT THE MEWP STAYS WITHIN THE WORK DIAGRAM.

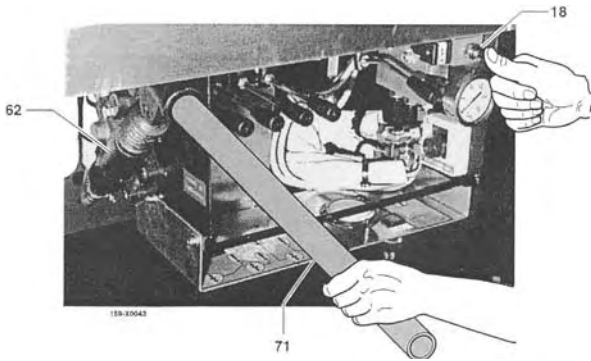

AFTER HAVING BROUGHT THE WORK PLATFORM BACK TO ITS RESTING POSITION, IT IS OBLIGATORY TO REFER TO AN AUTHORISED REPAIR SHOP TO PERFORM THE NECESSARY REPAIRS AND TO SEAL THE SOLENOID VALVE MANUAL CONTROL PUSH-BUTTON AGAIN.

Bringing down the platform using the emergency controls

In case of fault on the work platform controls, or of an accident or fainting of the operator on the work platform, the operator on the ground must bring the work platform back down as soon as possible without however any prejudice to safety, proceeding as follows:



ON LORRY-INSTALLED WORK PLATFORMS, THE EMERGENCY CONTROL PANEL CAN BE DRAWN OUT TO ENABLE MANOEUVRING THE MACHINE FROM OUTSIDE THE LORRY. IN THIS CASE, IT IS FORBIDDEN TO WORK FROM INSIDE THE LORRY, SO AS TO AVOID ANY DANGER DUE TO POOR VISIBILITY.

- start up the vehicle engine should it not be running, using the cab controls;
- go onto the deck of the vehicle and open the lock or padlock which locks the hood protecting the emergency controls on the turret, then open the hood to access the emergency controls;
- should the vehicle engine not be running, start up the emergency motor pump (optional) if present, pressing the relevant push-button (33). In the very special case in which the engine does not start up and the emergency motor pump has not been installed, the operator on the ground must prepare the hand pump for operation by fitting the handle (71) into its place, and instruct a person on how to use it properly;
- press on the lever which allows the extensions to retract (4G), until they have been completely retracted;
- if the extension does not move, this means that some safety device on the boom has tripped, locking the movements of the work platform. In this case, turn the key switch (37 – Fig. 07-C) which actuates the main solenoid valve of the hydraulic system cutting off the emergency electric circuit.

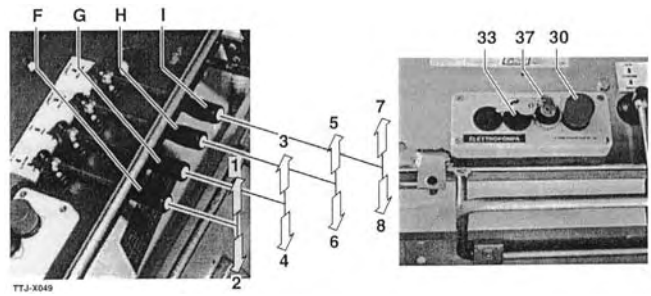

THE OPERATOR ON THE GROUND MUST USE THE KEY SWITCH ONLY AND EXCLUSIVELY WHEN IT IS NECESSARY TO RETRACT THE WORK PLATFORM WHEN THE EMERGENCY CONTROLS ARE NOT WORKING DUE EITHER TO A FAULT OR TO TRIPPING OF AN EMERGENCY ELECTRIC CIRCUIT DEVICE. KEEPING THE KEY SWITCH TURNED (37 – FIG. 07-C), THE OPERATOR AT THE EMERGENCY CONTROLS MUST RETRACT THE WORK PLATFORM MAKING SLOW MOVEMENTS AND PAYING GREAT ATTENTION DURING THE MANOEUVRE. HE MUST REMEMBER THAT THE SAFETY OF THE OPERATOR ON THE WORK PLATFORM DEPENDS ENTIRELY ON HIS EXPERIENCE AND SKILL, SINCE EVERY SAFETY DEVICE COULD BE OUT OF ORDER. THE OPERATOR IS RESPONSIBLE FOR KEEPING THE MEWP WITHIN THE WORK DIAGRAM.

- move the lever (4G – Fig. 07-C) again. This allows retraction of the extensions, until they are entirely retracted;



SHOULD IT BE IMPOSSIBLE TO RETRACT THE EXTENSION EVEN THIS WAY, TAKE OFF THE LEAD SEAL OF THE MANUAL CONTROL (18 – FIG. 06-C) ON THE SOLENOID VALVE, AND INSTRUCT A PERSON ON HOW TO KEEP IT PRESSED, SO AS TO ENABLE USE OF THE EMERGENCY CONTROLS ON THE TURRET, THEN REPEAT THE EXTENSION RETRACTION OPERATION.



USE OF THIS PUSH-BUTTON INVOLVES THE SAME DANGERS AS USE OF THE KEY SWITCH (37 – FIG. 07-C).

- turn the turret using the relevant lever (5H-6H – Fig. 07-C) until the indexes on the turntable coincide;
- lower the job almost completely (81 – Fig. 07-C) (only on the Ti series);
- lower the main boom (2F – Fig. 07-C) until it rests on its stand;
- close the jib completely (81 – Fig. 07-C) (only on the Ti series);

- bring the operator down from the work platform, and/or provide first aid if needed.



IF THE LEAD SEAL HAS BEEN TAKEN OFF ANY SAFETY COMPONENT IN ORDER TO LET THE MEWP COME DOWN, OR IF THERE IS A FAULT ON THE EMERGENCY ELECTRIC CIRCUIT, YOU MUST CALL IN AN AUTHORISED REPAIR SHOP, IN ORDER TO CHECK AND REPAIR THE MEWP AND RESTORE THE LEAD SEAL.

Driving on the road

While driving, comply with traffic regulations of your country and with the following advice:

- always keep the proper headway and driving speed;
- look frequently at the dashboard instruments to see whether the vehicle is working properly;
- pay special attention at cross-roads, underpasses and narrow passages;
- pay special attention to people on foot and bicycles;
- when parking, make sure the vehicle does not hinder traffic;
- do not let the vehicle sway, as the considerable weight of the MEWP could make the vehicle list (in curves, due to the wind, while overtaking other vehicles, etc. etc.);
- before starting out, some driving training is needed.

USE AND RESTRICTIONS

INTENDED USE

The mobile elevating work platforms Series T(TV) and Series TJ(TJV) were designed, built and classified as extendible structures for lifting people and things to enable performance of overhead work from the work platform. You may get onto and off of the work platform only when the machine is folded down and in its travelling position. Their application on self-moving or drawn vehicles is subject to the authorisation and the instructions issued by the Manufacturer of the vehicle and to compliance with current traffic regulations in the country of destination. The working range depends on the kind of vehicle and set-up, including stabilisation. To use the MEWP properly, there must not only be the operator or operators inside the WP, but there must also always be an operator near the vehicle, aware of what is going on and ready at any moment to undertake any emergency operations. Within the WP, one is allowed to use the tools required for maintenance operations, as long as the maximum capacity provided for equipment load is not exceeded equipment load shown on the work platform, on the machine identification plate or in the "Technical Data" chapter of this manual.



NEVER USE THE MEWP EXCEPT FOR PROFESSIONAL PURPOSES. NEVER INVOLVE IN ITS USE ANY PEOPLE WHO ARE NOT EXPERT, AS THESE COULD LEAD YOU TO COMMIT SERIOUS MISTAKES.

THE OPERATOR IS RESPONSIBLE FOR MAKING SURE THAT THE MAXIMUM LOAD PROVIDED FOR IS NEVER EXCEEDED ON THE WORK PLATFORM.

IMPROPER USE

Non-compliance with the rules and instructions laid down below shall constitute improper use of the machine:

- Use of the machine to perform any operations other than those for which it has been designed and built, as described in the chapter on "Intended Use".
- Use of the machine to lift and move loads (for example as a crane).
- It is forbidden to use the emergency controls to lift people (or animals) onto the work platform who are unable to manoeuvre the controls. The emergency controls must be used only in case of emergency, to bring the operators back to earth when they are not able to manoeuvre because of sudden illness or machine fault.
- Use of the MEWP supported by structures outside the MEWP itself.
- Going onto, leaving and/or loading the platform after it has been raised up from its travelling position.
- Use of the machine with procedures different from those laid down in this manual.
- Use of the MEWP by unauthorised people, or else to evacuate people from danger areas.
- Non-compliance with the maintenance programmes laid down by the Manufacturer, or the use of non-original spare parts.
- Lack of compliance with current safety regulations. Lifting and leaving the machine unguarded.
- Performing of operations and/or modifications on the machine involving the variation of components or of operation parameters set by the Manufacturer (e.g. putting any material on the bottom of the WP to raise its floor level).
- Increase the surface exposed to the wind, for example by applying panels, flags, banners, etc.
- Changing the calibration of the hydraulic circuit valves. Tampering with any sealing of the machine components.
- Using the machine outside the permitted temperature range: from 0°C to + 40°C, or under unexpected weather conditions.
- The use of the platform with the vehicle off-level beyond the permitted limit (1°), or with the floor of the WP slanted for more than 5° compared to horizontal.
- Use of the platform on slippery or unsteady surfaces, or on surfaces with a slope of more than 5° compared to the horizontal plane.
- It is forbidden to perform any operation, using the platform, which might lead to a risk of fire or explosion (welding,

using free flames, etc.). It is forbidden to use the platform in areas where there is a risk to the environment in case of leakage of hydraulic mineral oil. On request, the Manufacturer may provide machines pre-set for using biodegradable, environmentally friendly oils.

Any improper use or negligence as described above will imply:

- immediate cancellation of the warranty made with the Manufacturer or is legal representative at the moment the purchase was made;
- cancellation of any liability on the part of the Manufacturer for damage things, animals or people.



**IMPROPER USE MAY DAMAGE THE MACHINE
THUS LEADING TO DANGEROUS SITUATIONS
FOR THE PERSONNEL RESPONSIBLE FOR
RUNNING IT, OR FOR THIRD PARTIES.**

USE LIMITS

It is forbidden to use the machine under and in:

- Conditions of poor visibility;
- Fire-hazardous areas and activities;
- Corrosive environments;
- Explosive environments;
- Environments with powder which is hazardous for the health of the operator;
- Closed areas;
- Underground areas;
- Inside magnetic fields;
- When wind speed is over 60 Beaufort (45 km/h);
- Presence of live wires (stay at the necessary distance);
- Presence of people and/or animals within the working range of the machine;
- In areas where there is a pollution hazard for the environment due to leakage of mineral oil;
- Countries other than the one in which the machine was first put at work (rules in different countries may be incompatible, etc.).

CLASSIFICATION

Rated load

The rated load on the work platform is shown on the machine identification plate or in the section on "Technical Data – F" of this manual.

Expected life

The expected life of the MEWP is about 40,000 cycles, considering light and intermittent working (5 cycles an hour, 20 hours a week, 40 weeks a year). A cycle means the lifting of the platform from the boom stand, the extension of the telescoping boom and return to resting position. When the MEWP has done more than 40,000 cycles, you will have to undertake general overhauling of the machine at the Manufacturer's shop.

TRAINING REQUIRED FOR THE STAFF RUNNING THE MACHINE

Training required for the operator

To run the mobile elevating work platform, only expert and especially trained personnel must be used. The personnel used for this job must:

- have specific training on the use of extendible platforms;
- have specific instruction on proper use of the controls, the safety devices and on all the operations which can be performed using the machine. This instruction must be effected by qualified personnel of the Manufacturer or of his authorised representative, and must include some practical working trials;
- have the capacity of deciding – at the end of the training period – which is the best and safest way to bring down and put the WP back in place under various WP positioning conditions;
- have learnt the manual in its entirety and have signed a statement to this effect;
- be perfectly aware of all laws and regulations regarding the use of extending platforms in the country of use;
- be aware of the restrictions on use and of the kind of use classified as improper;
- be aware of the working and stability limits of the machines and of the precautions which must be taken depending on environmental conditions (escarpments, slopes, compactness of the ground, etc.);
- perfect physical condition able to satisfy legal requirements in each country.



**A QUALIFIED OPERATOR MUST NOT USE ILLICIT
DRUGS OR ALCOHOL, AS THESE CAN AFFECT HIS
REFLEXES AND CAPACITY OF CONCENTRATION. AN
OPERATOR USING MEDICAL DRUGS MUST HAVE A
MEDICAL CERTIFICATE STATING THAT HE IS IN
CONDITION TO OPERATE THE WORK PLATFORM.**

The operator shall perform the following tasks:

- Using the MEWP under the above mentioned provisions and instructions.
- Bringing the work platform back down in case of fault or tripping of any safety device, following the procedures listed in this Use Manual.
- Perform daily maintenance as shown in section "D" of this Use Manual. 'Perform the controls and tests which are incumbent on the operator.
- Stop the MEWP and cull for intervention by Specialised Technical personnel or by a Repair Shop authorised by the Manufacturer in case of faults or to perform any maintenance and/or operations defined as of exclusive pertinence to such personnel.

Training required for the specialised engineer

Every time you need to operate on the machine in case of faults, or you need to perform routine maintenance, you must call in the

Specialised engineer. This personnel must have read and assimilated this manual before the machine is delivered, and must be authorised to operate on the machine by the Manufacturer or by his legal representative. The Specialised Engineer must have the basic education needed to work on the machine and must have basic technical training with experience in the fields of installation (electricity and hydraulics) and mechanics. This personnel is responsible for performing all those tasks which involve: operation on the installations, the safety devices or components of the machine; routine or re-scheduled maintenance operations; check-up and testing operations which re-incumbent on such personnel alone.



Should there be no Specialised Engineer, or should he not be present, or in case of unscheduled maintenance operations, refer to an Authorised Repair Shop or to the Manufacturer.

GENERAL SAFETY RULES

RULES CONCERNING PEOPLE

- Always wear the prescribed personal safety devices, approved and certified for purposes of accident prevention, for example, according to the features of the environment where the machine is working: skid-proof shoes, gloves, ear-guards, reflector jackets, breathing sets, helmets, safety goggles, safety belts. Refer to the employer concerning current safety regulations. In the EEC countries, individual safety devices must be provided with an "EC" marking.
- Do not wear rings, wrist-watches, jewellery, loose or hanging clothing items such as ties, ripped clothes, scarves, unbuttoned jackets or shirts with open zippers which can get stuck in moving parts.
- Gala the platform and the work platform using the steps and the hand-rails.
- Get into the work platform only when it is in its resting position, on its stand. Come in only through the opening on the sides, after having lifted up the safety bar closing the opening off.
- Make sure the closing bar of the platform entrance compartment is always down and fastened to its safety device.
- Once you get into the work platform, before actuating the controls, fasten the safety belt at once to the special eyeholes inside the work platform.
- Manoeuvring and use is reserved only to the running personnel, the operator inside the work platform, or the operator on the ground in case of emergency. While using the platform, the driver's place on the turret must be occupied by an operator expert in emergency operations, and trained and able to act at once in case of need.
- Should the work platform be used by two people at the same time, the operators must be careful to avoid any accidents due to the use of bulky or dangerous objects (power saws, etc.).
- It is forbidden to lean out from the work platform putting any objects between the operator and the floor.

- Do not get onto the vehicle floor and do not stay within the working range of the MEWP while the platform is running.
- It is forbidden to throw objects from or to the work platform.
- During the manoeuvre of the work platform, the operators must not lean out of the work platform in order to avoid any danger of injury against machine parts.

RULES CONCERNING THE MACHINE

- The Manufacturer shall be held harmless f or any accidents, during the use of the platform, due to non-compliance on the part of the user with any current laws, provisions, prescriptions and rules on this matter.
- The machine has been designed for being used at temperatures between 0°C and + 40°C, and must be operated only within this temperature range. The manufacturer shall be held harmless for any accidents due to use of the machine outside this temperature range.
- When ambient temperatures near 0°C you must make the machine run for a few minutes (10 to 15) with no load, so as to warm up the hydraulic system allowing the machine to start up gradually.
- Read the Use and Maintenance instruction manual carefully before starting up, using, performing maintenance or other operations on the machine. 'Read, understand and comply with the instructions on all the safety plates or stickers on the machine before starting up, actuating, repairing or performing maintenance on the machine.
- Before every use of the machine, check proper operation of all the devices, especially the safety devices, while checking the safety of the actual working conditions as well.
- It is forbidden to use the control valve lever which controls the adjustment of the attitude of the work platform, except when the MEWP is at rest.
- After having adjusted the attitude of the work platform, fasten the lever using its padlock (if present).
- Vertical thrust is not allowed.
- Horizontal outward thrust of the work platform must not exceed:
20 daN for 1 person;
40 daN for 2 or more people.
- It is strictly forbidden to go up info or down from the work platform, or load any equipment on the same, when the work platform is raised up from is resting position.
- Always keep the steps leading lathe vehicle floor or to the platform, and the work platform floor, free of oil, grease and mud.
- Never put any loads inside the work platform while driving or transporting the vehicle.
- Do not carry any free loads, tools or other objects on the floor of the vehicle while driving or transporting it.
- Drive or transport the machine only and exclusively with its arm down and in rest position.

Rules concerning driving on the road

The Mobile Elevating Work Platform can be installed on a lorry of a type approved for driving on roads. Before driving on a road, make sure the vehicle complies with current laws.

RULES CONCERNING THE PLACE AND SETTING UP

Choosing the workplace

- When choosing the place to position the vehicle, make sure that it is sufficiently level, the maximum admitted slope is 5°. Check the area for the presence of holes, underground pipes, manholes, weak ground, hanging wires (electricity, telephone, etc.).
- Should it be absolutely impossible to park on a level surface, put the vehicle with its cab looking uphill, aligned along the steepest slope, never across it; this will give you maximum stability.
- Cordon off the area under the radius of the platform.
- The supporting plates provide stabiliser pressure on the ground. When the pressure on the surface of the supporting plates is greater than the maximum admitted pressure on the ground, you must increase the supporting surface by applying an underlying layer of steady material (e.g. wooden planks). The underlying surface must be laid down so that the plates rest on the centre of the supporting surface. The Manufacturer on request by the Customer, can provide suitable supporting surface enlargement plates.
- Stabilise the machine on the ground and lift it up so that the wheels when being used are lifted up by about 10 mm above the ground. First lift up the front wheels, then the back wheels, so as to avoid overloading the rear axle of the vehicle.



SOME MEWPS MAY BE SET UP WITH ONLY TWO STABILISERS, WHILE ON OTHER MACHINES, WHEREAS ON OTHER MACHINES THE TYRES OF THE VEHICLE MAY HAVE TO CONTRIBUTE TO THE STABILITY OF THE RAISED PLATFORM. IN SUCH CASES, IT IS NECESSARY TO LEAVE AT LEAST 2 WHEELS OF THE VEHICLE (GENERALLY THE FRONT ONES) RESTING FIRMLY ON THE GROUND. AT THE SAME TIME, AND BEFORE ANY USE, YOU MUST CHECK THE PERFECT CONDITION AND WORKING PRESSURE OF THE TYRES. BEFORE USING THE MACHINE, CHECK ON THE "CHECK BOOK (ENCLOSURE 8)" WHETHER AND HOW THE TYRES SHOULD REST ON THE GROUND SO AS TO HELP STABILISE THE RAISED PLATFORM.

- Always level the vehicle by actuating the stabilisers separately, referring to the spirit level near the control valve. The maximum slant allowed is 1°. The floor of the work platform must never slant by more than 5° compared to the horizon.



ONE OF THE MOST FREQUENT REASONS FOR ACCIDENTS IS TIPPING OVER OF THE MACHINE DUE TO IMPROPER POSITIONING OR USE.

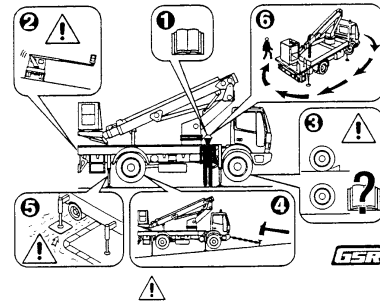

- 1 Read and understand the instruction manuals.
- 2 The slant must not be greater than permitted.
- 3 The wheels must be above ground if/as provided for by the instruction manuals.
- 4 The vehicle must be anchored against sliding.
- 5 All the stabilisers must rest steadily on firm ground.
- 6 Sight-check the positioning before using the platform.

The operator is responsible for taking effective steps against the risk of skidding (wedges under the wheels, additional fastenings, etc.) of the vehicle, stabilised on the ground when using the elevated platform.

Never use the MEWP for non-professional purposes; and never involve people who are not expert, as this could lead you to commit serious mistakes.

The operator is responsible for making sure that the maximum load provided for is never exceeded on the work platform.

Safety distance from escarpments and ditches

Use the machine at a sufficient safety distance from escarpments and ditches. This distance – in the case of non-reinforced escarpments or ditches – also depends on the kind of ground. A rough rule is the following (see Fig. 04-A):

should the ground tend to slide down or be made of filling earth, then the safety distance (a) must be double the depth of the ditch (b)

$$a = 2 \cdot b$$

should the ground be compact and not tend to slide, the safety distance (a) must be the same as the depth of the ditch (b).

$$a = 1 \cdot b$$

The safety distance is to be measured from the foot of the ditch (c).

Safety distance from power lines

Always keep a sufficient safety distance, according to current national regulations, when there are power lines passing in the range of the machine. This is especially true when these are hanging lines which have not been turned off by specialists, or the conditions of which are unknown.

Voltage (V)	Minimum distance (m)
Up to 1000 V	1
over 1 kV upto 110 kV	3
over 110 kV upto 220 kV	1
over 22 kV to 380 kV	5



THIS PLATFORM IS NOT INSULATED!

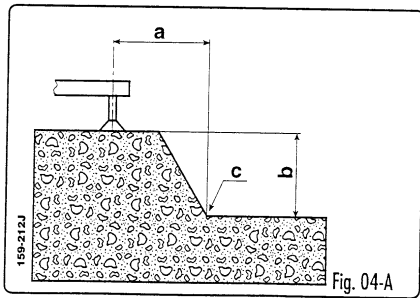

Keep at a safe distance from power lines. Comply with specific current national regulations. If you do not know the rated voltage of the line, always keep at a minimum distance of 5 m.

Effect of wind on platform operation

Strong wind can overload the structure of the platform. Check wind speed continuously while using the machine. The maximum admitted wind speed is 6th degree Beaufort (about 45km/h).

When the allowed wind speed is exceeded, stop working and bring the platform back to its resting position. Since the platform is not very high, you can use the following table as reference to gauge the effects of the wind.

Force of the wind Beaufort	Denomination	Wind speed		Wind effects
		m/sec	km/h	
0	calm	0 - 0.2	1	Calm, the smoke goes straight upwards
1	light	0.3 - 1.5	1-5	Wind direction can only be seen looking at the smoke. Wind indicators are idle
2	light breeze	1.6 - 3.3	6-11	Leaves are moving, the wind can be felt on the face.
3	light breeze	3.4 - 5.4	12-19	Leaves and small branches are moving
4	slow breeze	5.5 - 7.9	20-28	Dust and paper sheets are lifted up, slender, rods are moved
5	strong breeze	8 - 10.7	29-38	Small waves on water surfaces
6	strong wind	10.8 - 13.8	39-49	Roads are bent, it is difficult to use umbrella
7	tight wind	13.9 - 17.1	50-61	The trees are moved it is difficult to walk against wind
8	stormy	17.2 - 20.7	62 - 74	Trees' branches break. It is very difficult to walk in open areas
9	tempest	20.8 - 24.4	75 - 88	Small damages to buildings (roofing tiles wind fall down)
10	violent tempest	24.5 - 28.4	89 - 102	Big damages to the buildings, trees uprooted

Working with poor visibility

It is forbidden to work with little lighting or poor visibility. The headlamps the vehicle are not sufficient to ensure good visibility. Should you have to work with poor visibility or during the night, you must take every step needed to ensure good visibility throughout the operating field of the platform.



LOT ENSURING VISIBILITY, OR ENSURING IT ONLY PARTIALLY OR IN ONE DIRECTION, MAY LEAD TO EXTREMELY SERIOUS RISKS FOR PEOPLE.

FORESEEABLE SPECIAL USE CONDITIONS

OPERATION IN SPECIAL CLIMATES AND ENVIRONMENTS

Working in cold climates

When temperatures are around 00C, you must prepare or check the following supplies, as well as taking the following precautions:

- With temperatures around "00C", you must let the MEWP run idle for a few minutes (10 to 20) so as to allow it to gradually reach its steady state.
- With ambient temperatures around 00C, you must put special additives into the fuel tank to prevent some substances contained in the fuel from solidifying, as this would jam small tubes in the injection pump and injectors. Jamming of these tubes would lead to difficulty in starting up and running the engine. Also, these additives, if constantly used, ensure longer life of the fuel feeding system and steadier operation of the engine.
- Use lubricants and hydraulic oil compatible with the temperature accord. ing to the instructions on the lubrication table.
- Make sure the battery is always completely charged.

Working in hot climates

- Use lubricants and hydraulic oil compatible with the temperature according to the instructions on the lubrication table.
- Check the level of the electrolyte in the battery with greater frequency than provided for by the routine maintenance programme.
- Frequently check the level of the engine coolant, use the proper liquids containing ethylene glycol in order to raise the boiling point and to safeguard the cooling circuit from scaling.

Working in dusty environments

- Frequently check the conditions of the hydraulic fluid in order to prevent dust getting into the circuit and damaging the hydraulic parts.
- Clean the cylinder rods and the telescopic boom extensions frequently.

TROUBLESHOOTING

The following is a list of simple problems which you can solve on your own, without needing any special equipment. For problems which do not fall within this list, refer to the Authorised Repair Shops or to your dealer.

TROUBLE	CAUSE	REMEDY
The power take-off does not engage.	Mechanical control stiffened due to oxidation, dirt, etc./not enough pressure on the pneumatic control.	Clean, lubricate, adjust /accelerate the engine to get the right pressure.
Vibration while working, movements too slow.	Oil too cold/insufficient hydraulic oil level/air in the circuit.	Manoeuvre idle for a few minutes to bring the oil to the right temperature /top up the level/bleed the circuit leading the cylinders to the end of their stroke; repeat the operation until the problem is solved.
Slow movements and difficulty raising the structure.	Pump not efficient/ overpressure valves dirty/seizure or mechanical resistance of the articulations.	Replace the pump/clean the valves/lubricate the parts involved.
After having positioned the stabilisers, the platform does not rise.	Imperfect positioning of the stabilisers.	Actuate all the stabilisers at once to make sure pressure reaches all the cylinders.
After having brought the platform down to rest, the stabilisers do not retract.	Imperfect platform settling manoeuvre.	Repeat the manoeuvre making sure that the boom fits into its seat.
After having retracted all the stabilisers, the yellow warning light does not go off.	Imperfect manoeuvre.	Repeat the manoeuvre making sure that all the stabilisers are at the end of their stroke.
The booms come down while the platform is elevated.	Dirty lock valves/worn cylinder gaskets.	Stop operations at once and refer to the After-Sales Service.
The stabilisers move with raised boom.	Safety devices partly inefficient.	Stop operations at once and refer to the After-Sales Service

operator training centre

When hiring access equipment we strongly recommend taking advantage of one of our one day operator training courses

As Facelift is an accredited IPAF (Independent Powered Access Federation) training centre you can be sure that your staff will be trained to a high standard and receive an internationally recognised qualification.

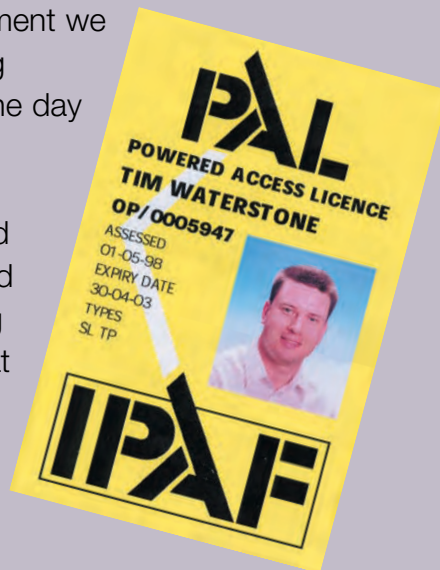

Courses can take place on your own premises or at one of our training centres, situated in Hickstead, Iver, Southampton and Liverpool.

We can train your personnel on any of the following equipment:

- (SL) Scissor Lift
- (SPB) Self Propelled Boom
- (VMP26) Truck/Van mounted to 26m
- (VMP200) Truck mounted over 26m
- (VPP) Vertical Personnel Platform
- (TP) Trailer/Push around

The one day course* covers site safety, practical demonstration, sole usage and site risks and includes a theory test.

*(two day course for VMP200)

Successful candidates are issued with the IPAF PAL card, widely accepted by both the CITB and Health And Safety Executive.

For further information or to arrange a training course call us today on:
0800 0 72 55 72

