



## **SP18AJ/SP18A**

The horizontal/vertical steering and control system is a standard feature of this working platform which can be easily operated and controlled.

The integrated smooth system monitors the travelling, hoisting and swiveling speed continuously and makes any necessary adjustments automatically.

The powerful all-wheel drive (4x4) and the full floating axle give the platform an excellent off-road capability.

The full warranty period for the SP18AJ and the SP18A is 2 years, with another 3 years on top of it for the parts.

AICHI equipment is extremely reliable. The high-quality products have been designed for daily use in the most difficult conditions.



**Working Height: 20 m**



Specifications	SP18AJ	SP18A
----------------	--------	-------

Reach Specifications		
----------------------	--	--

Platform Height	18.2 m	
Horizontal Outreach	15.8 m	16.7 m
Swing	360 degree, continuous	
Platform Capacity	227 kgs	
Platform Rotator	180 degrees (90,90)	
Jib Range of Articulation	130 degrees (+70,-60)	N/A

Dimension Data		
----------------	--	--

A: Platform Size	1.8 m x 0.75 m (Std), 2.4 m x 0.75 m (Opt)	
B: Overall Width	2.43 m	
C: Tailswing	2.36 m	
D: Overall Height	2.64 m	
E: Overall Length	10.04 m	9.17 m
F: Wheelbase	2.50 m	
G: Ground Clearance	0.255 m	
Gross Vehicle Weight	12,100 kgs	12,100 kgs

Chassis		
---------	--	--

Drive Speed 4WD	5.5 km/h	
Gradeability 4WD	24 degrees	
Tires	15 x 19.5, foamfilled	
Axle Oscillation	STD	

Power Source		
--------------	--	--

Diesel Engine	Isuzu A 4JB1, PAA-22	
Max. Output	44.3 KW/2,400 rpm	
Fuel Tank Capacity	150 liter	

Safety Features		
-----------------	--	--

H-V-Control	STD	
Sandblast Protection	STD	
Travel Speed Control	STD	
Rotation Speed Control	STD	
Lifting Speed Control	STD	
All Motion Alarm	STD	
Lever Guard	STD	

Technical specifications may change without notice!

## SP18AJ

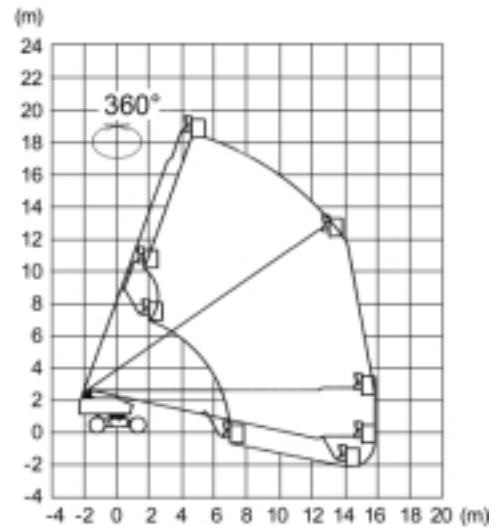
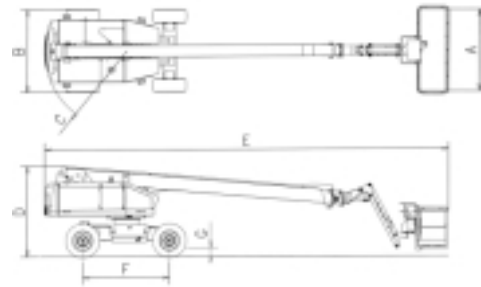

## SP18A

